

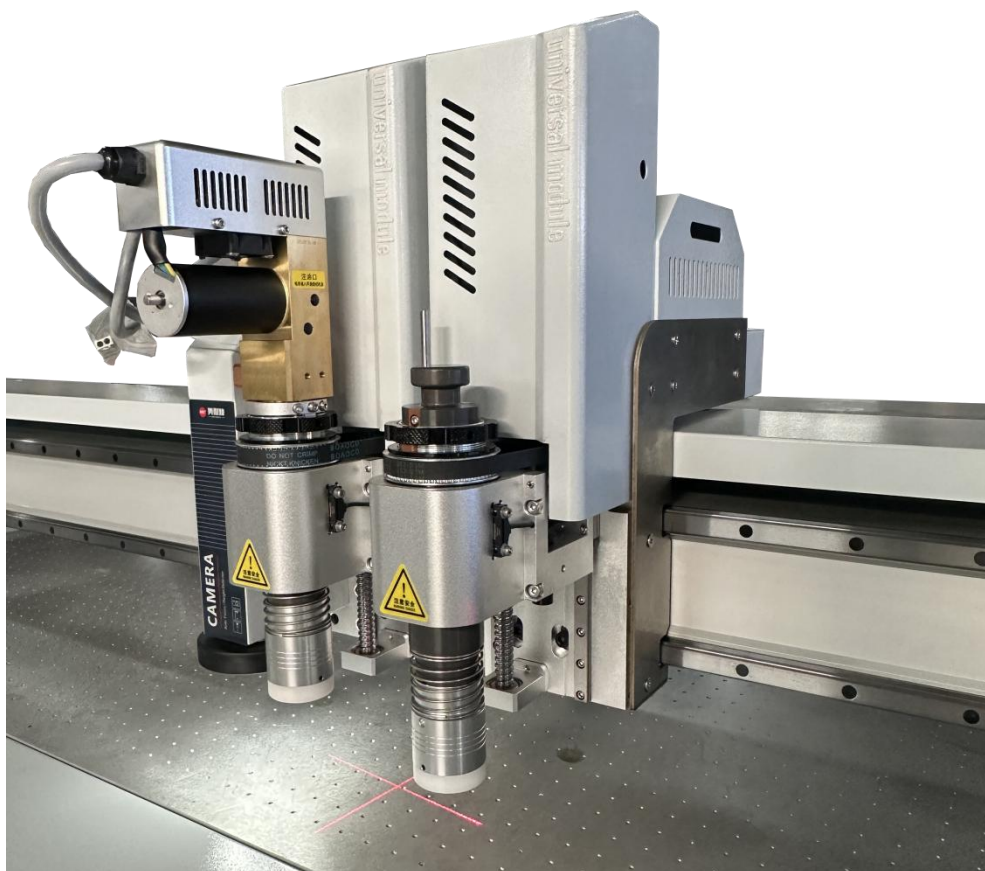

# Technical Proposal



C5016 — Intelligent Cutting Machine





## ● About us

### Hangzhou Chaohan Intelligent Equipment Co., Ltd.

Founded in 2010 and headquartered in Hangzhou, China, we specialize in **designing and manufacturing premium CNC equipment** for global markets. Our comprehensive product range includes:

- High-Speed Vision-Guided Router Series
- High-Precision Machining Centers
- Multi-Functional Intelligent Cutting Systems
- Fiber Laser Cutting Machines
- CO<sub>2</sub> Laser Cutting Solutions

### Manufacturing Excellence

Operating from an **5,000 m<sup>2</sup> facility** in Yuhang Liangzhu, our vertically integrated production features:

- Sheet Metal Fabrication Workshop
- Precision Assembly Center
- Dedicated R&D Departments for:
  - Software Development
  - Mechanical Engineering
  - Machine Tool Processing

Supported by **35+ skilled professionals**, we maintain an annual production capacity valued at **¥40 million** with streamlined manufacturing processes refined over a decade.



### Industry Applications

Our solutions serve diverse sectors including:

- Advertising & Signage • Craft/Gift Production • Hardware & Mold Making • Architectural Modeling • Electronics Manufacturing • Leather Goods • Decorative Materials • Woodworking & Furniture.etc.



## Collaboration Models

Beyond our core product lines, we offer:

- OEM/ODM Partnerships
- Integrated Online & Offline Support

## ● Technical Parameters

No.	Content	Specification
1	Air Pump Power	7.5kw
2	Total Capacity	9.5kw
3	Cutting Area	2500mm×1600mm
4	Machine Size	6400mm×2585mm×1350mm
5	Cutting Speed	300-1800mm (depends on the material)
6	Cutting Thickness	≤50mm (depends on the material)
7	Working Environment	Temperature:0-35℃ Humidity:35%-80%
8	Transmission System	Imported servo drive+linear guide+bearings
9	Operating Voltage	AC 380V/220V±10% 50Hz
10	File	HPGL/PLT/DXF,etc.
11	Operating Characteristics	Can be connected to any CAD software, computer aided design and cutting simultaneously
12	Cutter Buffer Capacity	Rapid transfer for single-pass sheet changing cuts
13	Transmission Port	Standard ethernet port
14	Mounting Method	Vacuum adsorption for material fixing
15	Operating Interface	Touch screen
16	Feeding Method	High-performance belt auto-feeding (enables continuous cutting)
17	Standard Tools	Oscillating knife, non-oscillating knife, SmartCut software
18	Optional Tools	Router bit, rotary cutter, V-groove tool, foam cutter, creasing wheel, pen tool etc.
19	Cutting Materials	Composite materials, all kinds of corrugated cardboard, PVC cardboard, honeycomb board, PVC foam board, acrylic, KT board, aluminum-plastic board, fiber reinforced baseboard, rubber sheet, rigid foam board, adhesive-backed vinyl, reflective film, photographic gloss paper, rigid PVC photo panel, etc.





● **Details**

ITEM	Brand	PICTURE	CHARACTERISTICS
Servo Motor	INOVANCE		<p><b>Motor &amp; driver:</b> High-speed, high-precision Configuration</p> <p><b>Performance:</b> High accuracy with low inertia ensures operational precision and prevents step loss during operation.</p>
Digital Drive Controller	INOVANCE		
Cutter Head Motor	Swiss MAXON		<p><b>High-speed brushless motor:</b></p> <ul style="list-style-type: none"> <li>- High oscillation frequency</li> <li>- 10mm cutting thickness (material dependent)</li> </ul>
Air Pump	/		<p><b>Motor Specifications</b></p> <ul style="list-style-type: none"> <li>- Insulation: CLASS F</li> <li>- Windings: 150°C rated copper wire</li> <li>- Core: M800-50A cold-rolled silicon steel</li> <li>- Bearings: NSK bearings</li> <li>- Seals: Fluor rubber material</li> </ul> <p><b>Manufacturing Process</b></p> <ul style="list-style-type: none"> <li>- Equipment: MAZAK machining tools</li> <li>- Impeller precision: ±0.01mm</li> <li>- Housing: Single-</li> </ul>





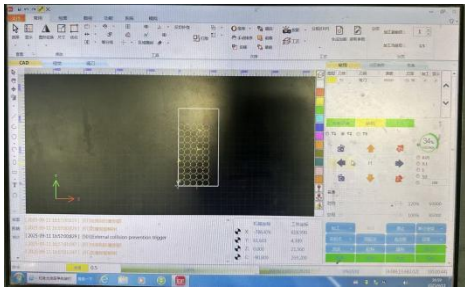

			<p>piece aircraft aluminum</p> <ul style="list-style-type: none"> <li>- Features: High heat dissipation, fine appearance, strong corrosion resistance.</li> </ul>
Guide Rail	LAPPING		<ul style="list-style-type: none"> <li>- High precision</li> <li>- Low noise</li> <li>- Wear-resistant design ensures long service life.</li> </ul>
Ball Screw	Taiwan <i>PMI</i>		<ul style="list-style-type: none"> <li>- High wear resistance</li> <li>- Precision accuracy</li> <li>- Exceptional stability.</li> </ul>
Timing Belt	Italy <i>MEGADYNE</i>		<ul style="list-style-type: none"> <li>- High rigidity</li> <li>- Superior durability</li> <li>- Silent polyurethane construction.</li> </ul>
Control System	Germany <i>AF Chip</i>		<ul style="list-style-type: none"> <li>- Proprietary CurveSmart optimization algorithm</li> <li>- 50% faster contour cutting</li> <li>- Significantly outperforms industry standards</li> </ul>
Electrical Circuitry	Germany <i>Schneider Electric</i>		<p>German-engineered exceptional stability surpassing industry standards</p>







			
Machine Frame	German-engineering philosophy		<ul style="list-style-type: none"> <li>- Domestically exclusive large-scale gantry machining center construction</li> <li>- 1.5-ton industrial-grade frame ensures vibration-free high-velocity cutting</li> <li>- Production-optimized for high-volume manufacturing</li> </ul>
Felt	Italian wool source		Premium imported Italian wool felt engineered for exceptional durability
Operating System	MNT	/	<ul style="list-style-type: none"> <li>- MNT SmartControl Platform</li> <li>- Intuitive interface minimizes operator training time</li> </ul>
Software	/		<ul style="list-style-type: none"> <li>- Proprietary Development Platform</li> <li>- Custom engineering capabilities</li> <li>- AutoNest one-click optimization</li> <li>- print-Cut workflow automation</li> <li>- SmartMark registration systems</li> </ul>
Warranty Coverage	/	/	<ul style="list-style-type: none"> <li>- Full machine warranty: 12 months</li> <li>- Software upgrades: lifetime entitlement</li> </ul>



● **Optional Tools and Applications**

Tools	Applications
<p><b>Ultra-frequency electric oscillating tool</b> (standard)</p>	<p>All kinds of corrugated, cardboard, KT board, gray board, composite materials, etc</p> 
<p><b>Non-oscillating tool</b> (standard)</p>	<p>Flexible materials less than 3mm thickness.</p> 
<p><b>Ultra-frequency pneumatic oscillating tool</b> (optional)</p>	<p>Seal parts and gaskets materials such as asbestos board, asbestos free board, PTFE, rubber board, fluorine rubber board, silica gel board, graphite board, graphite composite board, etc.</p> 
<p><b>Wheel cut tool</b> (optional)</p>	<p>Flexible materials such as UV fabric, carbon fabric, glass fabric and textiles, etc.</p> 
<p><b>Milling tool</b> (optional)</p>	<p>Acrylic, aluminum composite panel and MDF, etc</p>



	<p>within 20mm thickness.</p> 
<p><b>Multi-angle V-Cut tool</b> (optional)</p>	<p>Can make V-cut angles of 15°, 22.5°, 30° and 45° for cardboard less than 20mm thickness.</p> 
<p><b>Creasing tool</b> (optional)</p>	<p>Used in packaging industry for making cartons and boxes of corrugated board, cardboard and pp hollow board, etc.</p> 
<p><b>Kiss-cut tool</b> (optional)</p>	<p>All kinds of stickers, vinyl, engineering reflective film, etc.</p> 

● **Machine Design:**

➤ Design:

C5016 Intelligent Cutting Machine

- Frame Construction: Welded from **10mm-wall steel tubes**;
- Bed Treatment: **High-temperature tempered** to minimize deformation;



- Precision Machining: Bed processed via **large-scale gantry milling** for assembly accuracy;
- **Optimized Gantry & Beam:** cross-section, integrated with worktable to form rigid/reliable welded framework;
- Structural Validation: **FEA-optimized** for maximum strength and rigidity (Ref: C5016 drawing).

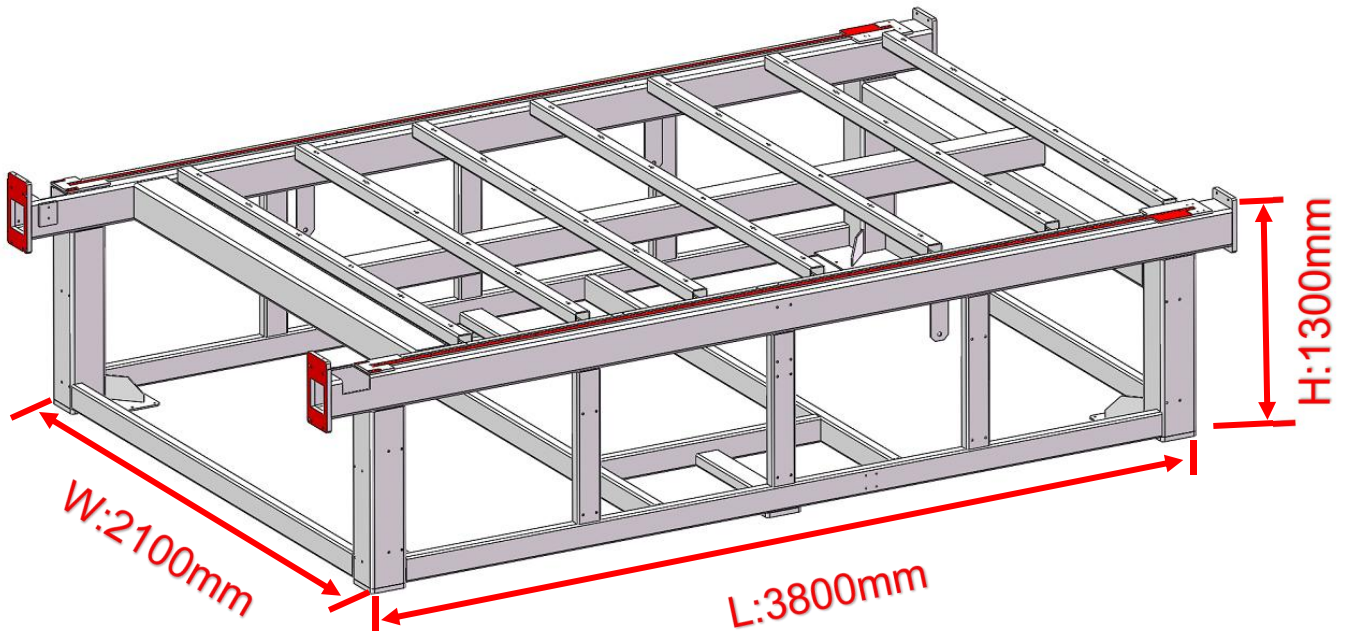

Tank chain (silent chain)

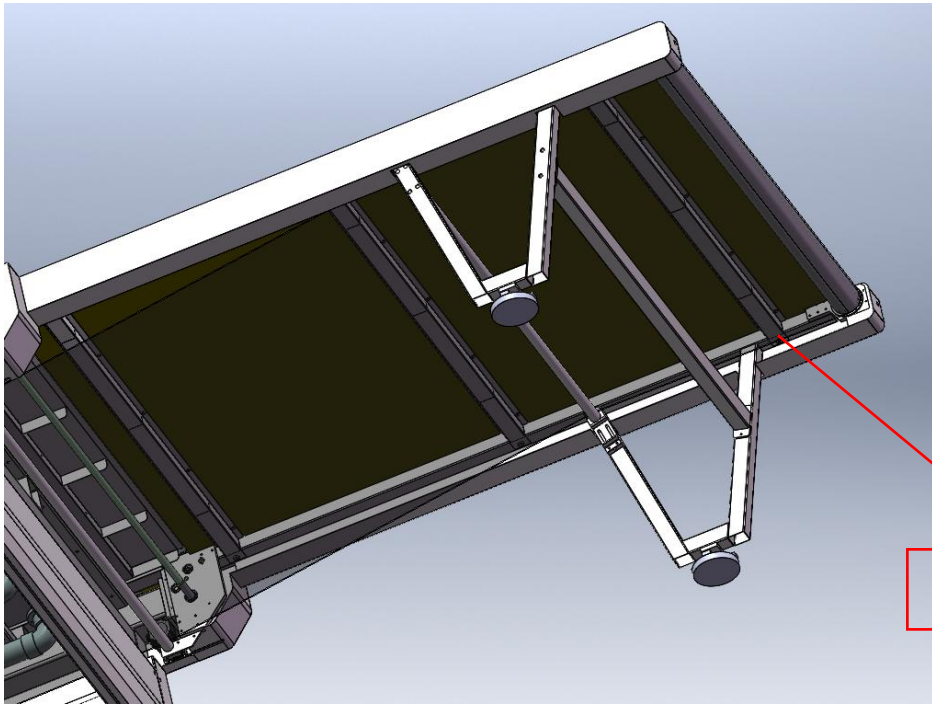

Collecting Platform

● 2 universal modules:



Universal Tool Module

CCD Camera

Oscillating Tool

Non-oscillating Tool



## ● **After-sales service**

### **A. After-Sales Service Commitment**

#### **1. Quality Assurance**

All products provided by our company are original factory packaging, compliant with the international ISO9001:2015 quality certification system. We will provide product technical documents (including installation manuals, product packing lists, Chinese user manuals, certificates of conformity, and warranty credentials, etc.).

#### **2. Delivery and Installation Timeline**

Upon receiving the letter of acceptance, our company will promptly deliver the goods to the user. Both the manufacturing and inspection of products are accompanied by quality records and testing data. For product performance testing, we conduct full-process and full-performance inspections. All products undergo a 72-hour fatigue test before leaving the factory and are only packed and shipped after being confirmed qualified. Upon arrival of the goods at your company, our technical personnel will immediately visit for installation and training.

#### **3. Product Delivery Time**

Depending on the model, delivery will be made within 25 days after contract signing.

#### **4. Warranty Commitment**

We provide a 12-month warranty for all products offered during the validity period of this supply agreement. Throughout the validity period, we offer full-day service on normal working days and lifelong technical support for all products.

#### **5. Response Time**

We will respond to customer needs within 24 hours.

#### **6. Service System**

As the equipment supplier, our company provides a guarantee system for the products offered in this tender: When equipment malfunctions occur, we will dispatch designated professional technicians to carry out on-site repairs or return repairs within the specified time, if necessary.

### **B. Product Price Commitment**

#### **1. Under equivalent competitive conditions**

Our company sincerely offers the most favorable prices to you without compromising product technical performance or altering product components.

#### **2. During the warranty period**



The supplier will provide free repair and replacement of component damage caused by quality issues. For component damage beyond the warranty period, the supplier will only charge cost price for provided accessories. In cases of equipment damage caused by the buyer's human factors, the supplier will charge cost price for repairs or provided accessories.

### **C. After-Sales Service Guarantee**

#### **Company Strength Assurance:**

Guided by the philosophy of "sincere service with utmost dedication," our company commits to responding to customer needs within 24 hours. We resolve customer issues through telephone, fax, Internet remote service, on-site visits, and other means.